

Car 51	
Page 1	of 4
Scale 1:48	

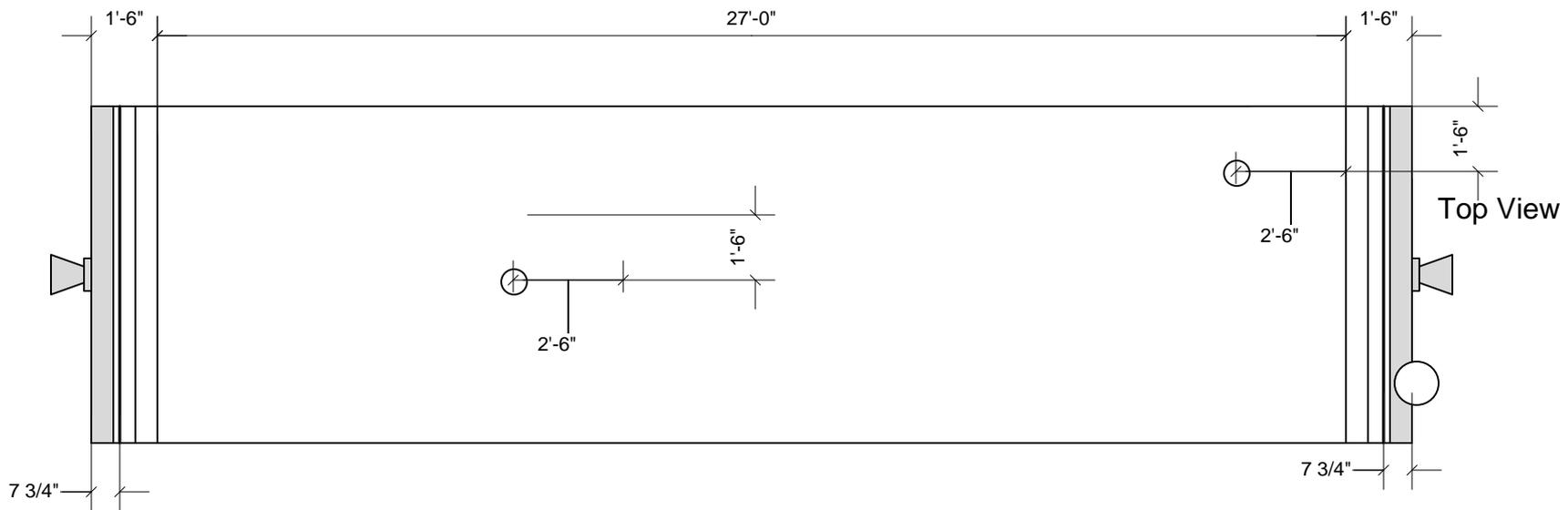

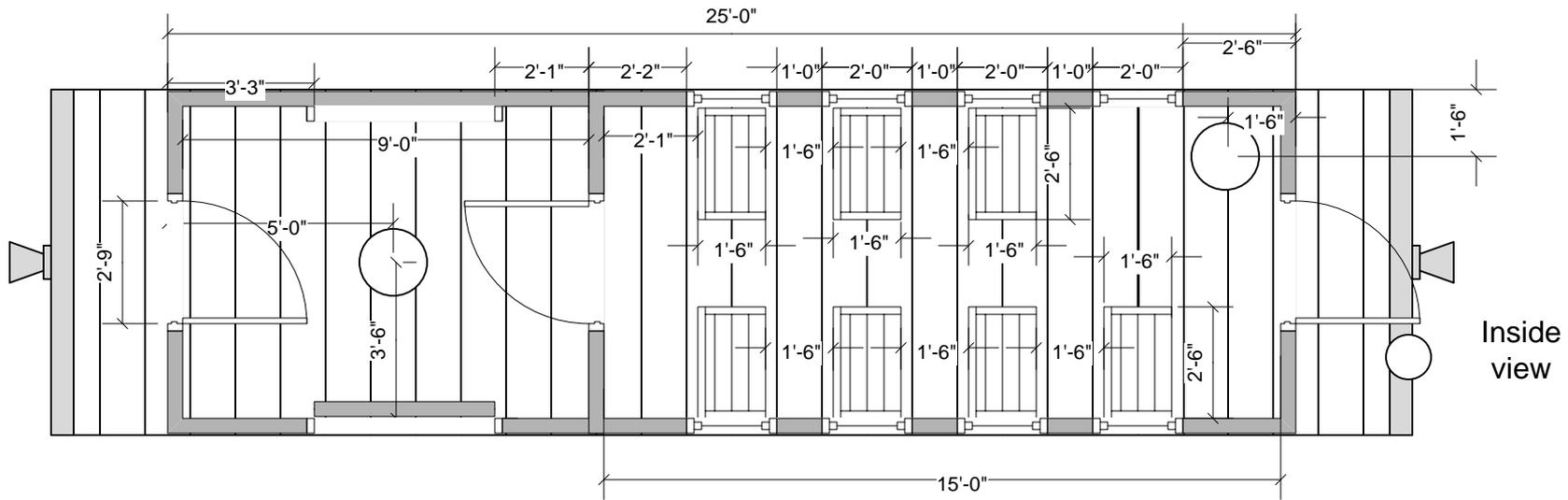
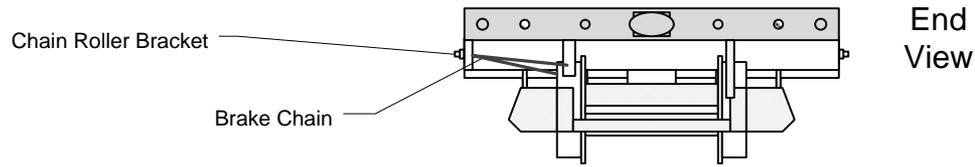

Brake Staff Lower Bracket. Details of Brake Staff, Pawl, Ratchet and Wheel shown on car pages

Chain Roller Bracket

Brake Chain

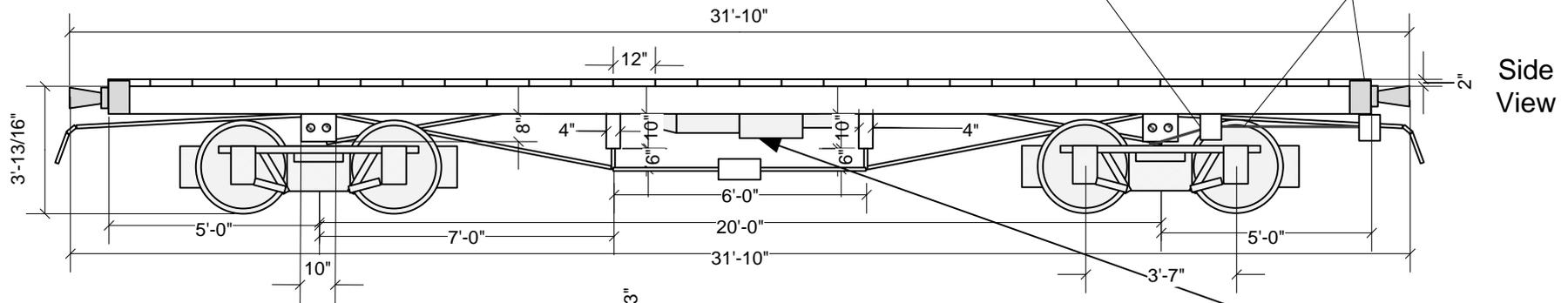

For details on Westinghouse brake rod connections see File Grandt-5040

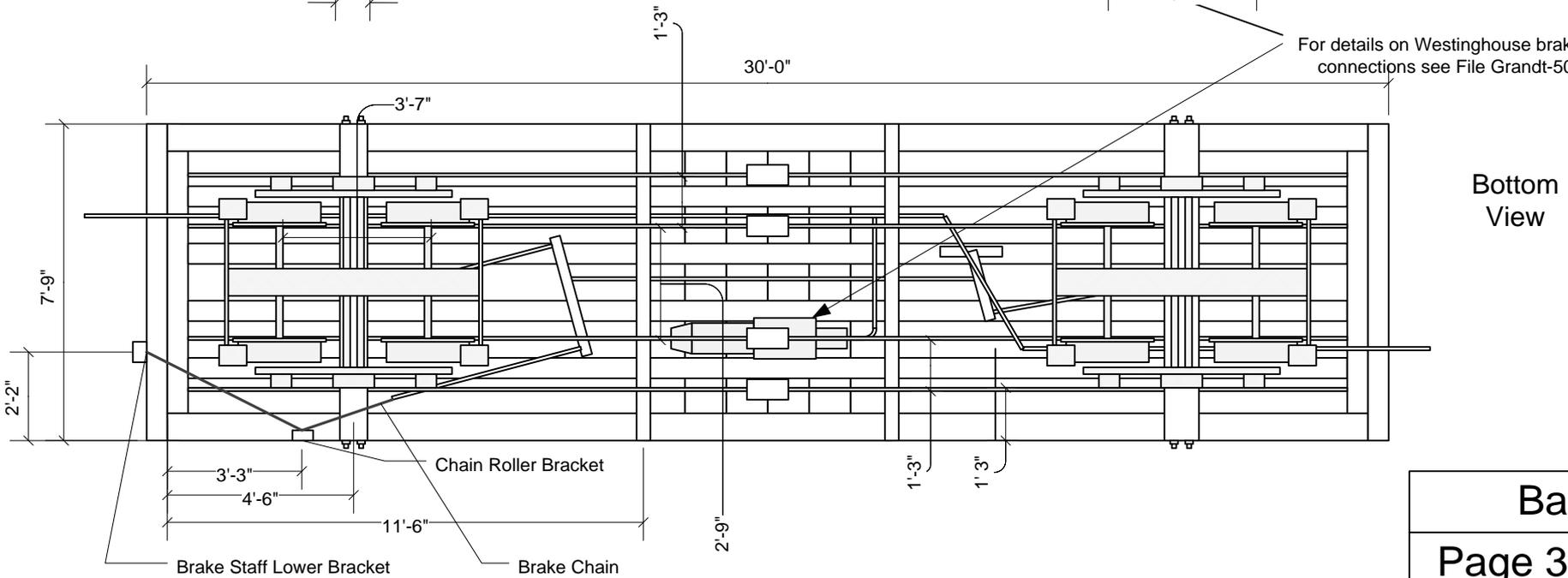

Base	
Page 3	of 4
Scale 1:48	

Brake Staff
Brake Staff Lower Bracket

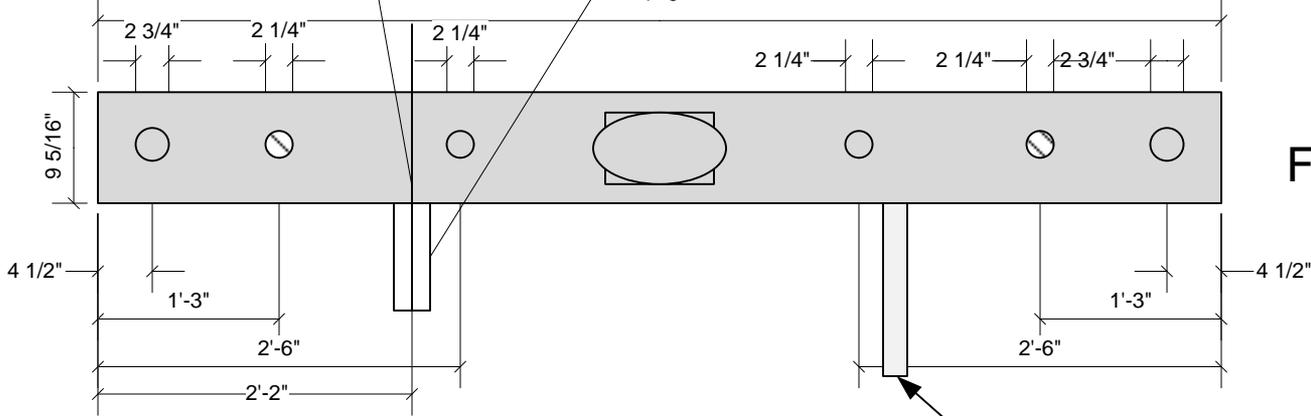

Front View

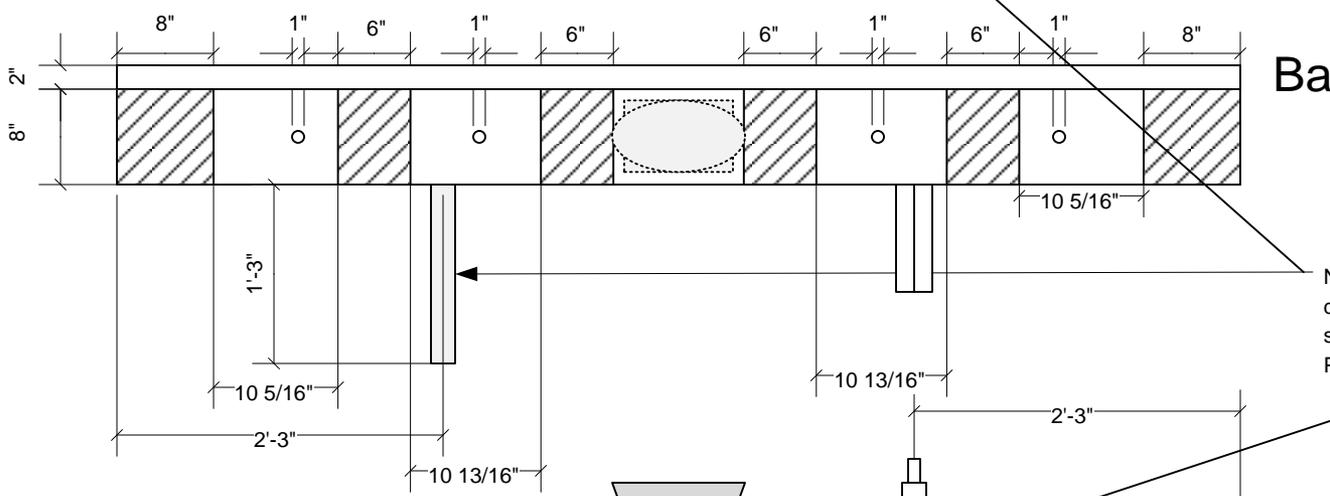

Back View

Note: Anglecock/Gladhand dimensions are nominal, for specific details, see File Precision-3307

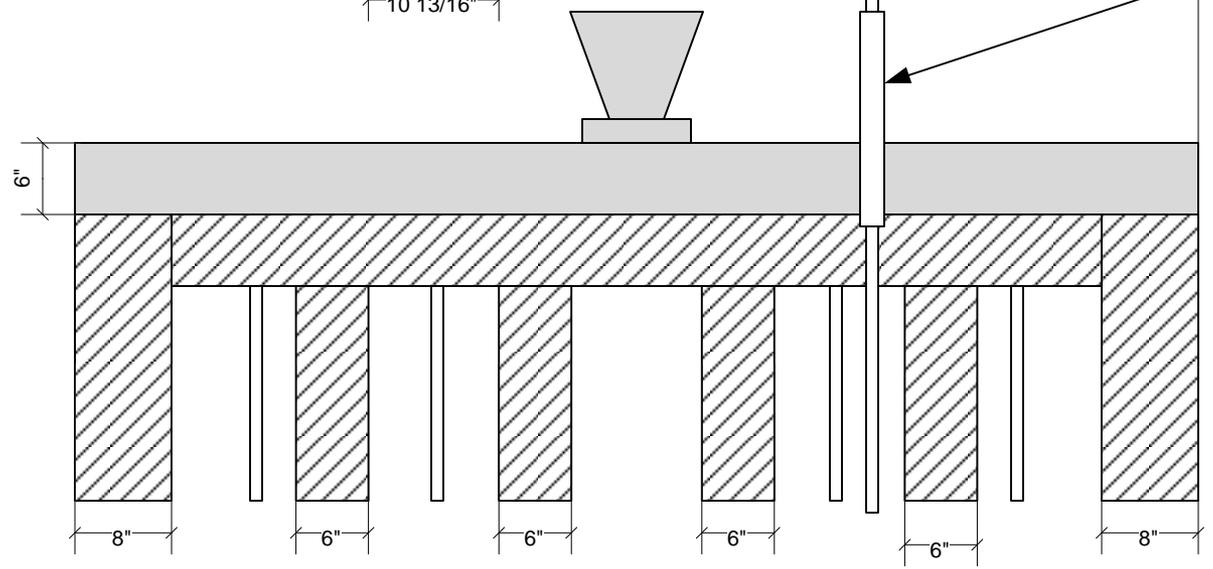

Bottom View

Side View

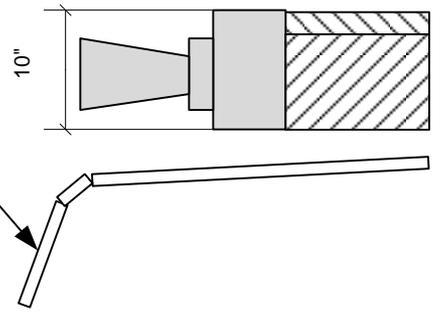

End Sill	
Page 4	of 4
Scale 1:16	